

ROBOTIC POOL CLEANER
RAPTOR©
BCZ94/BCZ94.L (with LED bar)



USER MANUAL

Thank you for purchasing Robotic Pool Cleaner. If you have any questions or issues, please contact your local dealer for customer service.

Contents

Important Precautions	1
Attention	3
I. Introduction	4
II. Safety	4
III. Specifications	5
IV. Operations	5
4.1 Panel	5
4.2 Remote control (Optional)	7
4.3 Filter cleaning	8
V. Assembly of transport caddy (Optional)	9
VI. Packing list	10
VII. Warranty	11

Important Precautions

1. Please read the manual carefully, and use the cleaner according to the manual. We are not held liable for any loss or injury caused by improper use.
2. Please do not allow children to ride on it or play with it as a toy.
3. In order to prevent severe damage to the cleaner, never power on it when it is out of the swimming pool.
4. It is forbidden to operate the cleaner when there are people in the pool, and the power supply should be connected to a leakage-protected and earthed socket.
5. In order to avoid overheating and potential damage for components, never cover the power supply.
6. In order to avoid any accident or damage, it is strongly recommended to fix the power supply indoor in at least 3.5m away from the swimming pool edge and connect the power supply with a fixed holder by using the safety rope.
7. Before power-on, make sure the filters be assembled and the cable be fully released to avoid any winding, which could affect the cleaner's performance or cause damage.
8. Hold the top handle when putting the cleaner into or lift it out of the water. Do not pull the cable.
9. It is forbidden to use the cleaner beyond its working conditions stated in the manual.
10. The cleaner should be stored in a cool and ventilated place, away from direct sunshine.
11. Only professionals can disassemble the cleaner and its power supply, otherwise the warranty will be invalidated.
12. It is forbidden to drop and hammer the cleaner and power supply.
13. Use the accessories recommended or sold by the manufacturer only.
14. It is strictly forbidden to place chemicals for water treatment inside the cleaner for spraying, otherwise the warranty will be invalidated.

Attention

1. Put into or lift out of the pool with the cleaner bottom towards the wall to avoid any possible scratches to the pool. Hold the top handle and put it into the pool. Let the cleaner immerse into the pool floor after emptying the air inside it (the air inside should be exhausted completely, otherwise its normal working will be affected).



2. Please hold the top handle only and never pull the cable when lifting it out of the pool.

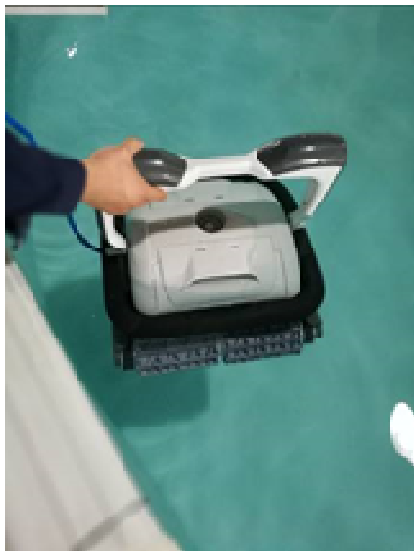

I. Introduction

The robotic pool cleaner HJ2032/HJ2032L is a new type of highly efficient and energy-saving swimming pool cleaning robot. Through its advanced computer-controlled program, it can clean the pool walls and bottom automatically. At the same time, it filters the pool water and gets rid of suspended particles without replacing the pool water. It is totally environmental-friendly. For safe operation, the cleaner works on 20V direct current.

Please read this user manual carefully before use.

II. Safety

Power supply needs to be placed in a proper position so as to reach the coverage for the whole pool, meanwhile as least 3.5m away from the swimming pool edge.

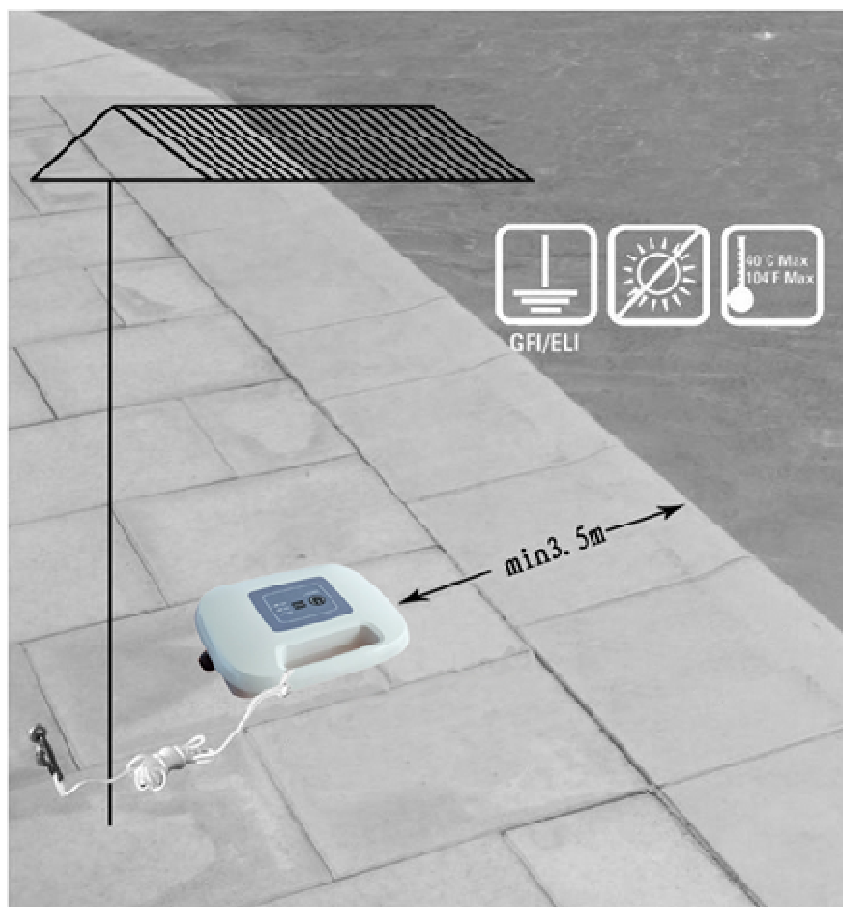

III. Specifications

1. Rated input voltage: 220VAC (230VAC)/110VAC (120VAC)
2. Frequency: 50Hz/60Hz
3. Output voltage: DC20V
4. Power: 200W
5. Cleaning cycle: 2H/3H/4H
6. Cable length: 18m
7. Filter capacity: appr. 20m³/h
8. Filter density: 10μm
9. Moving speed: appr. 12.5m/min
10. IP grade: Cleaner IPX8; Power supply: IPX5
11. Max. water depth: 2m
12. Working temperature: 0°C -40°C
13. Remote distance: >20m
14. Frequency of remote control: 433MHz

IV. Operations

4.1 Panel

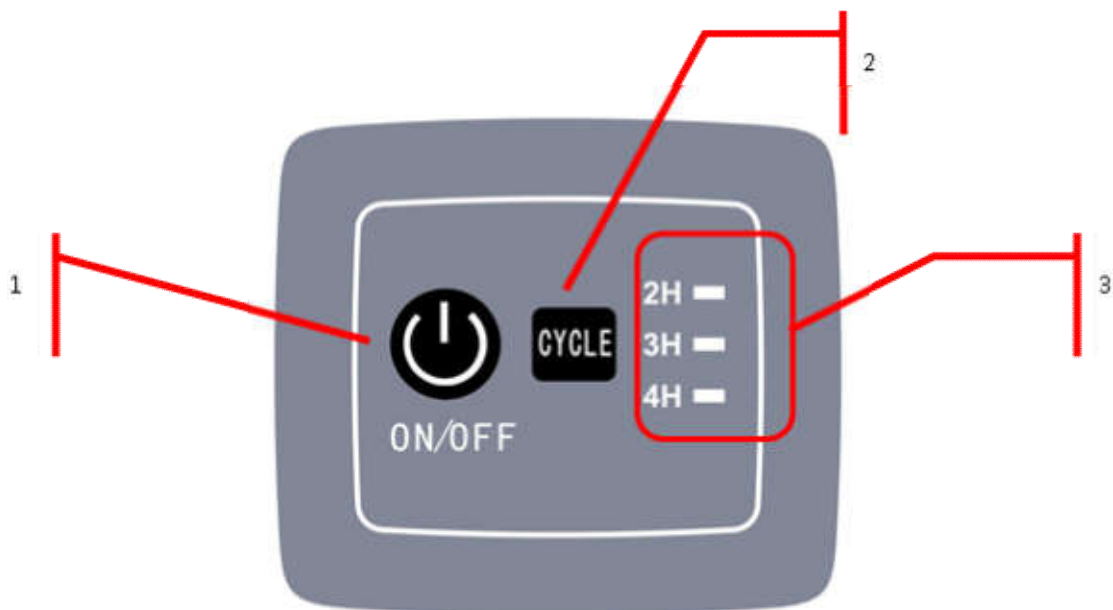

No.	Sign	Function		Instruction		
1	ON/ OFF	Power on/ off		Press this button, the cleaner starts to work; Press a second time, the cleaner is stopped.		
2	CYCLE	To choose working cycle		When the cleaner is on, press this button to choose preferred working cycle.		
3	Indicators	CYCLE indicators	2H flashes	Cleaner running for 2 hours		
			3H flashes	Cleaner running for 3 hours		
			4H flashes	Cleaner running for 4 hours		
			2H, 3H and 4H flash together	Working cycle finished		
			Fault Code	Trouble	Suggestion	
		Fault	2H and 3H flash together, with warning sound	Pump is overloaded	Stop the cleaner, check if anything is stuck in the impeller	
			3H and 4H flash together, with warning sound	Driving motor is overloaded	Stop the cleaner, check if anything is stuck in the belt	
2H and 4H flash together, with warning sound	Cleaner out of water		Exhaust the air inside the cleaner, immerge the cleaner and restart it.			

4.2 Remote control (Optional)

No.	Sign	Function	Instruction
1		Antenna	Signal reception
2		Indicator	Indicates status
3	3H	Cleaner running for 3 hours	Press the button, then the cleaner will work for 3 hours
4	4H	Cleaner running for 4 hours	Press the button, then the cleaner will work for 4 hours
5	STOP	Stop working	Press the button, then the cleaner will stop working
6	2H	Cleaner running for 2 hours	Press the button, then the cleaner will work for 2 hours
7	▲	Manual-Walk forward	Press the button, then the cleaner will walk forward
8	▼	Manual-Walk backward	Press the button, then the cleaner will walk backward

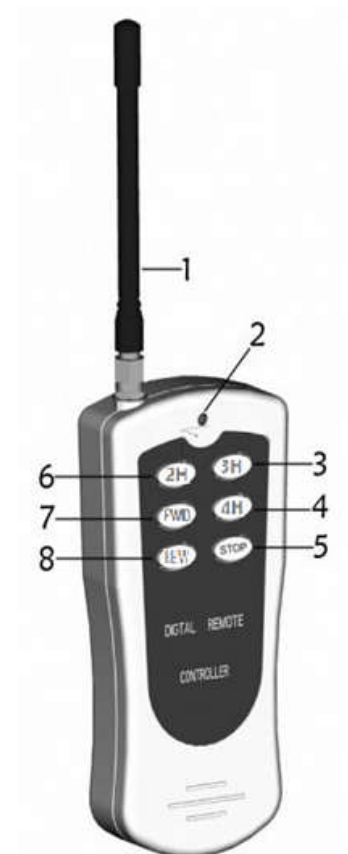

Note: Switching between automatic mode and manual mode needs to stop the cleaner by pressing STOP.

4.3 Filter cleaning

1. Lift the filter tray

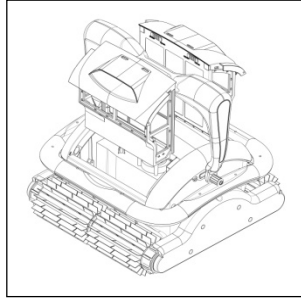

2. Push the buckles towards the middle and move the filter panel outwards

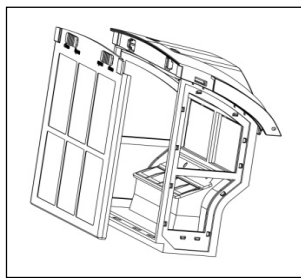
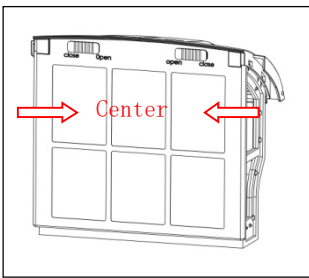

3. Clean the filters

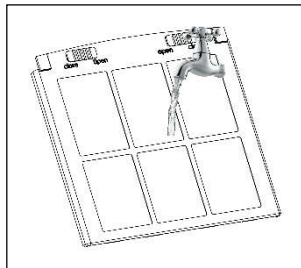
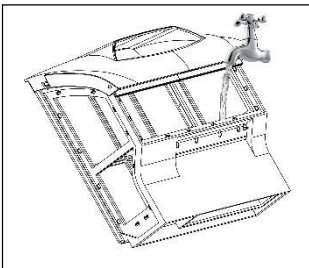

4. Slide the filter tray along the groove

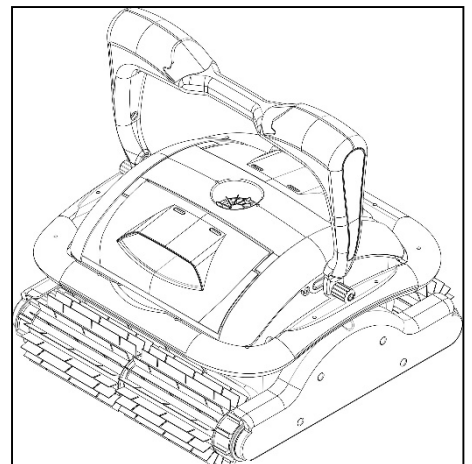
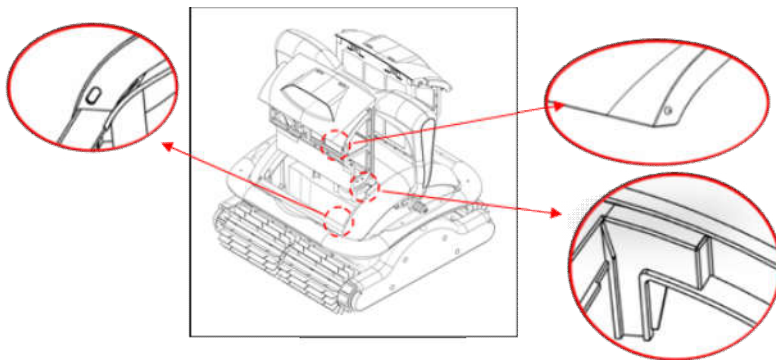

V. Assembly of transport caddy (Optional)

1. Open the package for assembling

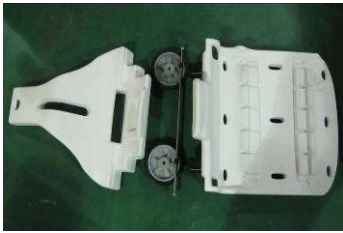

2. Put the connection part onto the plate



3. Insert the wheel axle

cover



4. Assemble the protecting cover and axle



5. Assemble wheels



6. Put on the nut



7. Tighten the nut



8. Assemble the top handle



9. Assemble power supply holder



10. Assemble cable holder



VI. Packing list

No.	Item	Name	Model	QTY (pc)	Remark
1	Cleaner	Cleaner body	HJ2032/HJ2032L	1	In carton
2		Power supply	HJ2032/HJ2032L	1	In carton
3		User manual & safety rope		1	In plastic bag
4		Foam		4	In plastic bag
5		Remote control (Optional)		1	In plastic bag
6	Transport caddy (Optional)	Top handle		1	In carton
7		Connection part		1	In carton
8		Plate		1	In carton
9		Power supply holder		1	In carton
10		Cable holder		1	In carton
11		Wheel axle		1	In carton
12		Wheel		2	In carton
13		Nut	M10	2	In plastic bag
14		Axle cover		2	In plastic bag
15		Protecting cover		2	In plastic bag

VII. Warranty

This product has passed all quality control and safety tests, conducted by the technical department of the factory.

Warranty information:

1. The warranty is covered for 24 months (only for motors and PCB) from the date of its original purchase.
2. This warranty is void if the product has been altered, misused, or has been repaired by unauthorized personnel.
3. The warranty extends only to manufacturing defects and does not cover any damage resulting from mishandling of the product by the owner.
4. The sales invoice must be presented for any claim or repair during the warranty period.

Please contact your local dealer for any warranty issues.

